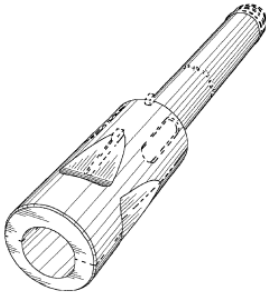
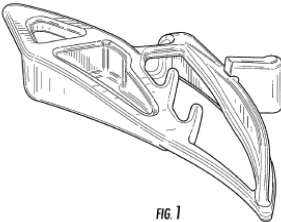
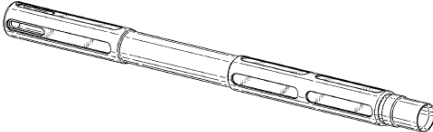

ACCESSORIES PARTS AND UPGRADES		
Item(s) Nos.	Item(s)	Patents
52200 52201 52202 52203 52204 52205 52206	APEX® 2 Barrel System	APEX® barrel system covered by US PATENT NO. 7275531 For use under US PATENT NO. 7699048
17023* 17051* 50000 50001 50303 51999* 52011 52013 52015 52023 52069 52012	APEX® Barrel System <i>(original design)</i>	APEX® barrel system covered by US PATENT NOS. 7275531; D561293* For use under US PATENT NO. 7699048* *Barrel system only U.S. Patent Feb. 5, 2008 Sheet 1 of 4 US D561,293 S  FIG. 1

ACCESSORIES PARTS AND UPGRADES		
Item(s) Nos.	Item(s)	Patents
38824 38876 38871	EMPIRE® HALO® Drive Cone and Drive Cone Kits	US PATENT NO. 6792933* *Drive Cone only Drive Cone for use under US PATENT NOS. 6109252; 6213110; 6701907; 6792933; 7343909; 8047191; 8061342; 8561600/ GB2322438
38924	EMPIRE® B2 Loader Upgrade Kit	For use under: US PATENT NOS. 5791325; 5947100; 7343909; 8061342; 8561600
38936	EMPIRE® FREEWAY™ Anti-Jam	US PATENT NO. D604371  FIG. 1
16900	EMPIRE® AXE REDLINE™ Board and Foregrip	For use under US patents: PATENT NOS. 6474326; 6637421; 7603997; 7610908; 7946285; 6601780; 6925997 Licensed for use under U.S. PATENT NO. 6311682; British PATENT NOS. GB2342710; GB2345953

ACCESSORIES PARTS AND UPGRADES		
Item(s) Nos.	Item(s)	Patents
52090	Empire® BT® Slice™ E-Grip w/Board	FOR USE UNDER US PATENT NOS. 6474326; 6637421; 7603997
99099	EMPIRE® BT™ Electronic Composite Grip Frame	For use under US PATENT NOS. 6474326; 6637421; 7603997
38946	Empire® Halo® Too Rip Drive® Kit	For use under US PATENT NO. 8387607
38925*	EMPIRE® MAGNA CLUTCH® Upgrade Kit	EMPIRE® MAGNA CLUTCH® Upgrade Kit for use under US PATENT NOS. 6109252; 6213110; 6701907; 6792933; 7343909; 7428899; 7921835; 8047191; 8061342; 8561600/ GB2322438 <i>*Drive Cone individually covered by US PATENT NO. 6792933</i>
36005	EMPIRE® PROPHECY® LTD Upgrade Kit	For use under US PATENT NOS.: 5791325; 5947100; 8061342; 8251050; 8561600
38781	EMPIRE® RELOADER B Upgrade Kit	For use under US PATENT NOS.: 5791325; 5947100; 7343909; 8061342; 8561600
38929	Empire® RF Loader Board Kit	For use under the following US patents: PATENT NOS. 5791325; 5947100; 7921835; 8448631; 8561600
38926	EMPIRE® RF Transmitter Link	For use under the following US patents: PATENT NOS. 5791325; 5947100;

ACCESSORIES PARTS AND UPGRADES		
Item(s) Nos.	Item(s)	Patents
	Kit	7921835; 8448631; 8561600
38920	Empire® Z2 RF Transmitter Link Kit	FOR USE UNDER: 5947100; 7921835; 8448631
38921	EMPIRE® Z2 Transmitter Harness	FOR USE UNDER: 5947100; 7921835; 8448631
16661*	GORILLA GRIP™ Feed Neck	US PATENT NOS. 7229105*; 7316431* <i>*Feed Neck only</i>
59400	GTI™ Electronic Grip Frames	For use under US PATENT NOS. 6474326; 6637421; 7603997
38870	HALO® Circuit Board with Z-Code	For use under the following US patents: PATENT NOS. 6792933; 7343909; 8061342; 8561600
38875	HALO® RIP DRIVE® Drive Assist Kit	For use under US PATENT NO. 7343909; 8047191; 8387607
43305	JT® TACTICAL® Barrel	US PATENT NO. D559923* <i>*Barrel only</i>

ACCESSORIES PARTS AND UPGRADES		
Item(s) Nos.	Item(s)	Patents
		
11545* 11530 11531 11516 11515 11540 11541 16854**	SUPER FREAK® Barrel Kit	Barrel kits barrel portions and barrel inserts for use under the following US patents: 6494195; 6823857; 7691759 *For APEX® 2 barrel systems and component parts: APEX® barrel system covered by US PATENT NO. 7275531; For use under US PATENT NO. 7699048 **Barrel system only
28904	V-35™ Upgrade Circuit Board for HALO®	For use under the following US patents: PATENT NOS. 6792933; 7343909; 8061342; 8561600

FACEMASKS AND GOGGLE SYSTEMS

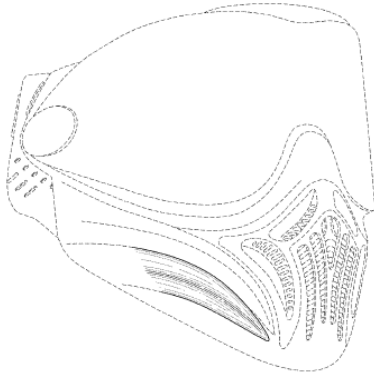
Item(s) No.(s)	Item(s)	Patent(s)
21710 21712 21713 21715	AVATAR Goggles	US PATENT NO. 8011026; 8549672 D703388 
23012 23020	EMPIRE® FLEX-8 FULL COVERAGE THERMAL Goggle	US PATENT NO. D527847

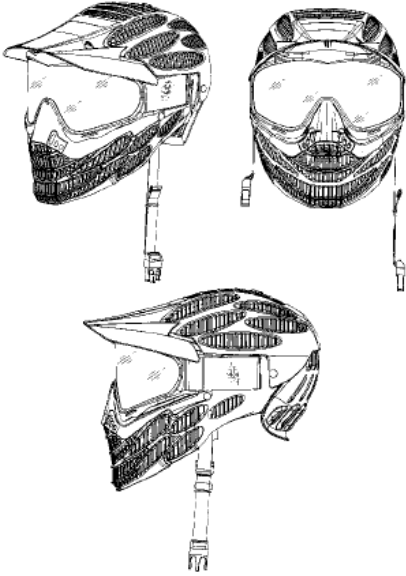
FACEMASKS AND GOGGLE SYSTEMS		
Item(s) No.(s)	Item(s)	Patent(s)
		
23011 23013 23019	EMPIRE® FLEX-8 Goggle	US PATENT NO. D529662

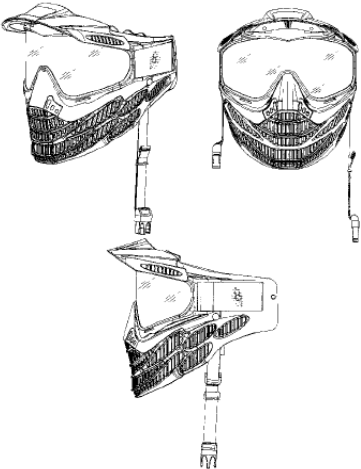
FACEMASKS AND GOGGLE SYSTEMS		
Item(s) No.(s)	Item(s)	Patent(s)
		
21630 21631 21632 21633 21634 21635 21627 21628 21629	EMPIRE® E-FLEX™ Goggle System	US PATENT NO. 8011026; 8549672
21610 21611	EMPIRE® E-VENT Goggle	US PATENT NO. 8011026; 8549672

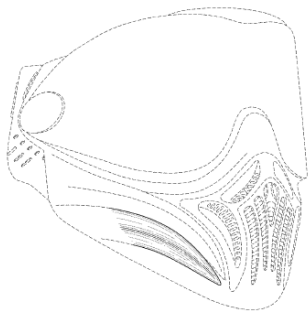
FACEMASKS AND GOGGLE SYSTEMS		
Item(s) No.(s)	Item(s)	Patent(s)
21612 21613 21614		D703388 
21900 21901 21902 21903 21904 21907 21908 21909	EMPIRE® HELIX® Goggle	US PATENT NO. 8011026; 8549672
23028	JT® CARNIVORE Goggle	US PATENT NOS. D571050; D548251; 7681257

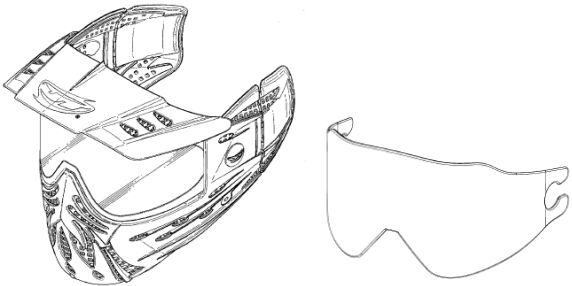
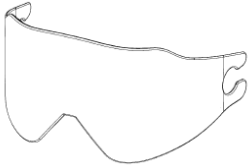
FACEMASKS AND GOGGLE SYSTEMS		
Item(s) No.(s)	Item(s)	Patent(s)
		
23033	JT® CARNIVORE “FULL COVERAGE” Goggle	US PATENT NOS. D548251; 7681257 
23069	JT® HEADSHIELD “ELITE” Goggle	US PATENT NO. D536833

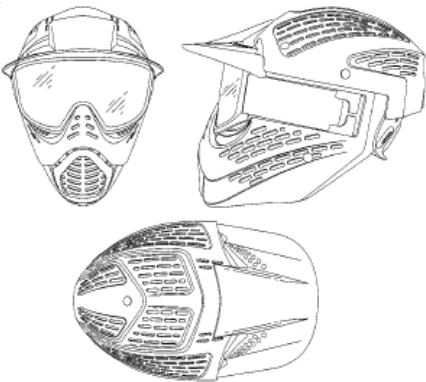
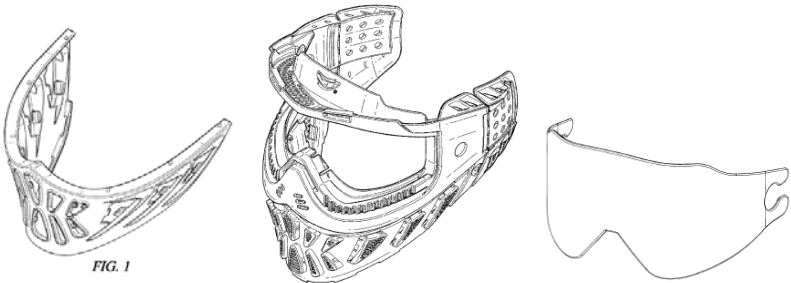
FACEMASKS AND GOGGLE SYSTEMS		
Item(s) No.(s)	Item(s)	Patent(s)
		
23029 23030 23034	JT® REAPER Goggle	US PATENT NOS. D570550; D570551; D548251; 7681257  <p>FIG. 1</p>
23044 23045	JT® STATUS THERMAL Goggle	US PATENT NO. D570552

FACEMASKS AND GOGGLE SYSTEMS		
Item(s) No.(s)	Item(s)	Patent(s)
		

LOADERS/HOPPERS		
Item(s) No.(s)	Item(s)	Patent(s)
52100 52101 52038 52068	EMPIRE® BT® RIP CLIP paintball loader <i>with RIP DRIVE</i>	PATENT NOS. US 5791325; 5947100; 5954042; 6109252; 6213110; 6701907; 6792933; 7343909; 8047191; 8061342; 8387607; 8561600/ GB2322438
30702	EMPIRE® eVlution® 4 paintball loader	US PATENT NOS. 5816232; 5954042; 8061342; 8561600 European Patent EP0878684 Canadian Patent No. 2236484 Licensed under PATENT NO. 5722383
38576 38588 38579	EMPIRE® HALO® TOO™ paintball loader	US PATENT NOS. 5791325; 5947100; 8061342; 8387607; 8561600
38520 38521 38522	EMPIRE® MAGNA DRIVE® paintball loader <i>with RIP DRIVE® Drive Assist</i>	PATENT NOS. US 5791325; 5947100; 5954042; 6109252; 6213110; 6701907; 6792933; 7343909; 7428899; 7832389; 8047191; 8061342; 8387607; 8561600/ GB2322438 US DESIGN PATENT NOS. D584776; D602537

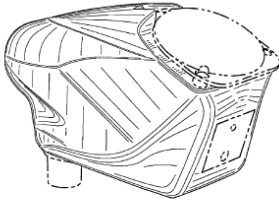
LOADERS/HOPPERS		
Item(s) No.(s)	Item(s)	Patent(s)
		 <p>FIG. 1</p>
38536	EMPIRE® PROPHECY® LTD paintball loader	PATENT NOS. US 5791325; 5947100; 6109252; 6213110; 6792933; 7428899; 7770569; 7832389; 8047191; 8251050; 8387607; 8561600; 8746225/ GB2322438
38540 38544 38541 38542 38543 38545 38546 38547	EMPIRE® PROPHECY® paintball loader	PATENT NOS. US 5791325; 5947100; 6109252; 6792933; 7428899; 7832389; 8047191; 8251050; 8387607; 8561600; 8746225/ GB2322438
38503 38504 38505	EMPIRE® RELOADER 2 paintball loader	US PATENT NOS. 5791325; 5947100; D544047

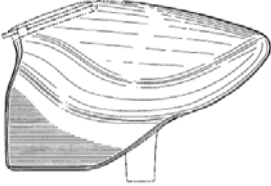
LOADERS/HOPPERS		
Item(s) No.(s)	Item(s)	Patent(s)
		
38509	EMPIRE® RELOADER B	PATENT NOS. US 5791325; 5947100; 5954042; 6109252; 6701907; 6792933; 7343909; 8047191; 8387607; 8561600; RE43,756/GB2322438
38585 38589	EMPIRE® SCION™ paintball loader	PATENT NOS. 6109252; 6213110; 8047191; 8104462; 8387607/GB2322438
30671 30672	EMPIRE® VLOCITY® Jr. paintball loader	US PATENT NOS. 5816232; 5954042; 8061342; 8561600 European Patent EP0878684 Canadian Patent No. 2236484 Licensed under PATENT NO. 5722383
30664 30667	EMPIRE® VLOCITY® paintball loader	US PATENT NOS. 5816232; 5954042; 8061342; 8561600; D572318 European Patent EP0878684 Canadian Patent No. 2236484 Licensed under PATENT NO. 5722383

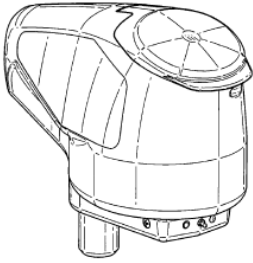
LOADERS/HOPPERS		
Item(s) No.(s)	Item(s)	Patent(s)
		 <p style="text-align: center;"><i>FIG. 1</i></p>
38580 38581 38587	EMPIRE® Z2™ paintball loader	PATENT NOS. US 5791325; 5947100; 6109252; 8047191; 8104462; 8387607; 8746225/ GB2322438 FOR USE UNDER: 7,921,835; 8,448,631
30362 30364	EXTREME RAGE OVERDRIVE® dB SOUND ACTIVATED hopper	US PATENT NOS. 5791325; 5947100
38557 38558 38559 38560 38561 38568 38569	HALO® B/HALO® V35 paintball loader <i>with RIP DRIVE® Drive Assist</i>	PATENT NOS. US 5954042; 6109252; 6213110; 6701907; 6792933; 7343909; 8047191; 8061342; 8387607; 8561600; RE43,756/ GB2322438
38551 38555	HALO® B/V35 paintball loader (<i>without RIP DRIVE®</i>)	PATENT NOS. US 5954042; 6213110; 6109252; 6701907; 6792933; 8061342; 8561600; RE43,756/ GB2322438

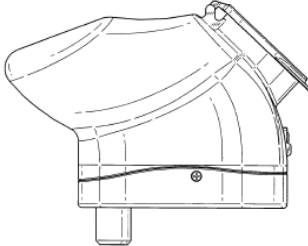
LOADERS/HOPPERS		
Item(s) No.(s)	Item(s)	Patent(s)
30714	JT® EVLUTION® LOADER (2013)	US PATENT NOS. 5816232; 5954042; 8061342; 8561600 European Patent EP0878684 Canadian Patent No. 2236484 Licensed under PATENT NO. 5722383
30679 30680	JT® VL® eVlution® III paintball loader	US PATENT NOS. 5816232; 7021302; 7357129 European Patent EP0878684 Canadian Patent No. 2236484 Licensed under PATENT NO. 5722383
30684 30677	JT® VL® EYE FORCE™ paintball loader	US PATENT NOS. 5816232; 5954042; 8061342; 8561600; D567303 European Patent EP0878684 Canadian Patent No. 2236484 Licensed under PATENT NO. 5722383  <i>FIG. 4</i>
30695	JT® VL® REVLUTION FORCE™ paintball loader	US PATENT NO. 7021302; 7357129; D567303

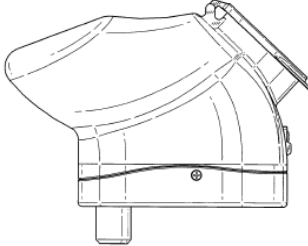
LOADERS/HOPPERS		
Item(s) No.(s)	Item(s)	Patent(s)
		Licensed under PATENT NO. 5722383  <i>FIG. 4</i>

PAINTBALL MARKERS		
Item(s) No.(s)	Item(s)	Patent(s)
17095 17096 17097 17099 17100 17102 17103 17104 17105	EMPIRE® BT® TM-15™ paintball marker	US PATENT NOS. 6474326; 6637421; 7603997; 7610908; 7946285; 6601780; 6925997; 8272373; 8336532
17060 17066 17067 17080	EMPIRE® BT® TM-7™ paintball marker	US PATENT NOS. 6474326; 6637421; 7603997; 7610908; 7946285; 6601780; 6925997; 8272373; 8336532
17020	EMPIRE® BT®-4 COMBAT paintball marker	U.S. PATENT NO. D587766
17120	EMPIRE® BT®-4 SLICE COMBAT paintball marker	U.S. PATENT NO. D587766; <i>other patents pending</i>
17125	EMPIRE® BT®-4 SLICE G36 paintball marker	U.S. PATENT NO. D587766; <i>other patents pending</i>
17126	EMPIRE® BT®-4 Slice G36 Elite	U.S. PATENT NOS. 6474326; 6637421; 7603997

PAINTBALL MARKERS		
Item(s) No.(s)	Item(s)	Patent(s)
		<p><i>APEX® 2 barrel system covered by or for use under. US PATENT NOS. 7,699,048; 7,275,531</i></p> <p><i>BT® RIP CLIP™ paintball loader covered by: PATENT NOS. US 5791325; 5947100; 5954042; 6109252; 6213110; 6701907; 6792933; 7343909; 8047191; 8061342; 8387607; 8561600/ GB2322438</i></p>
17023	EMPIRE® BT®-4 ERC paintball marker	US PATENT NOS. 6474326; 6637421; 7603997
16800 16801 16802 16804 16805 16806 16853	EMPIRE® AXE® paintball marker	US PATENT NOS. 6474326; 6637421; 7603997; 7610908; 7946285; 6601780; 6925997; 8272373; 8336532
17400 17401 17402 17403 17479 17480	EMPIRE® MINI® paintball marker	US PATENT NOS. 6474326; 6637421; 7603997; 7610908; 7946285; 6601780; 6925997; 8272373; 8336532

PAINTBALL MARKERS		
Item(s) No.(s)	Item(s)	Patent(s)
17481 17482 17484 17485 17486 17487 17488 17489 17490 17495		
16820 16821	EMPIRE® TEAM AXE® paintball marker w/REDLINE™ Foregrip	US PATENT NOS. 6474326; 6637421; 7603997; 7610908; 7946285; 6601780; 6925997; 8272373; 8336532 Licensed for use under U.S. PATENT NO. 6311682; British PATENT NOS. GB2342710; GB2345953
14270 14470 14471	PIRANHA GTI Plus Rampage™ electronic paintball marker	US PATENT NOS. 6474326; 6637421; 7603997
82050 82054 82000 82002	JT SPLATMASTER® Z-100	US PATENT NO. 7975683

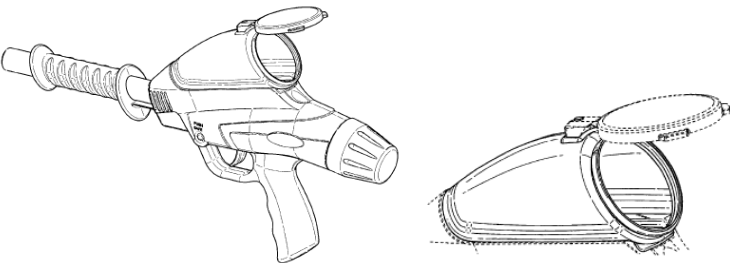
PAINTBALL MARKERS		
Item(s) No.(s)	Item(s)	Patent(s)
85062 85060 82010 82011	JT SPLATMASTER® Z-200	US PATENT NO. 7975683
82020	JT SPLATMASTER® Z-300 Sniper	US PATENT NO. 7975683
82009	JT SPLATMASTER® Z-90	US PATENT NO. 7975683
16639 16660	RAPTOR PUMP paintball marker	US PATENT NOS. 7426927; D536398 <i>*Hopper portion of marker also covered by D535339</i>
		 <p>The image contains two line drawings. On the left is a side view of a paintball marker, showing the pump handle, trigger, and barrel. On the right is a top-down view of the hopper (the top part of the marker), showing its curved shape and the opening for the paintball.</p>
13052*	TRILOGY™ Block Adapter	US PATENT NO. D520080* <i>*Block adaptor only</i>

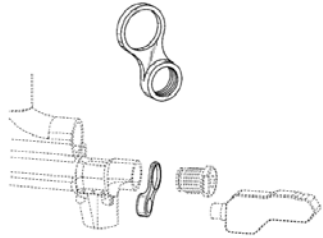
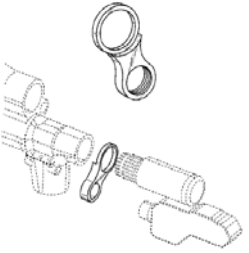
PAINTBALL MARKERS		
Item(s) No.(s)	Item(s)	Patent(s)
		
13052*	TRILOGY™ Mounting Block	US PATENT NO. D518118* <i>*Mounting block only</i> 
13051	TRILOGY™ paintball marker	US PATENT NO. D512109
13051*	TRILOGY™ Paintball Marker Grip Frame	US PATENT NO. D512109* <i>*Grip frame only</i>

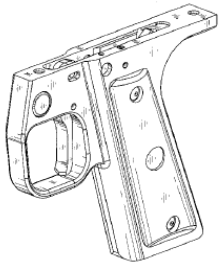
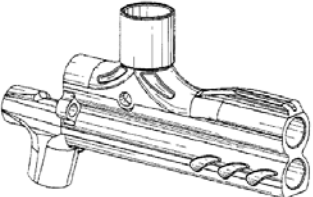
PAINTBALL MARKERS		
Item(s) No.(s)	Item(s)	Patent(s)
		
13052*	TRILOGY™ PRO Receiver Body	US PATENT NO. D512750* <i>*Receiver body only</i> 
13052	TRILOGY™ PRO™ paintball marker	US PATENT NOS. D513773
13051*	TRILOGY™ SPORT Receiver Body	D515150* <i>*Receiver body only</i>

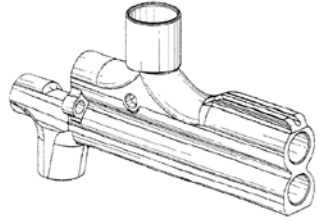
PAINTBALL MARKERS		
Item(s) No.(s)	Item(s)	Patent(s)
		
13051	TRILOGY™ SPORT™ paintball marker	US PATENT NO. D515149; D515550
16626	T-STORM™ paintball marker	US PATENT NO. 5634456; D594914
16950 16951 16952 16953 16954 16955 16956	EMPIRE® VANQUISH®	US PATENT NOS. 6474326; 6637421; 7100593; 7603997; 7610908; 7617819; 7640925; 7946285; 8191543; 8272373; 8336532 Licensed for use under U.S. PATENT NO. 6311682; British PATENT NOS. GB2342710; GB2345953
17130 17131 17132 17133	EMPIRE® BT® D*FENDER™ Marker	<i>Marker covered by or for use under:</i> US PATENT NOS. 6474326; 6637421; 7603997; 7610908; 7946285; 6601780; 6925997; 8272373; 8336532; 5791325; 6109252; 8047191; 8104462; 8746225/ GB2322438 <i>When sold with APEX® 2 barrel system, barrel system covered by or for use under:</i> US PATENT NOS. 7,699,048; 7,275,531 <i>When sold with SUPER FREAK™ barrel system, barrel system covered by or for use under:</i> 6494195; 6823857; 7691759

PAINTBALL MARKERS		
Item(s) No.(s)	Item(s)	Patent(s)
58500 58501 58502 58503 58504 58505 58506 58507 58508 58509	JT® IMPULSE® Marker	US PATENT NOS. 6474326; 6637421; 7603997; 7610908
81937 81935	JT® E-KAST Marker	US PATENT NOS. 6474326; 6637421; 7603997
16740 16741	JT® E-ICON marker	US PATENT NOS. 6474326; 6637421; 7603997
94708 94811	SPYDER® XTRA	US PATENT NOS. D593621; 8286622
94714	SPYDER® MR5	US PATENT NO. 8286622
15206	SPYDER® MR6	US PATENT NOS. 8286622; 8418682
15204 15205 94712 94713	SPYDER® MR100	US PATENT NO. 8286622

PAINTBALL MARKERS		
Item(s) No.(s)	Item(s)	Patent(s)
94716 94717		
15158 15159 94701 94702 94703 94704 94705 94706	SPYDER® FENIX	US PATENT NO. 8286622
15156 15157 94715 94812	SPYDER® VICTOR	US PATENT NO. 8286622
15206 94710	SPYDER® MRX	US PATENT NO. 8286622
15207	SPYDER® EMR5	US PATENT NO. 8286622
94802 94803	SPYDER® OPUS SPYDER® OPUS A	US PATENT NO. 8286622
94805	SPYDER® STORMER	US PATENT NO. 8286622